

AALFG4872

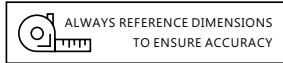

*Not shown to scale.

Aluminum Louver Swing Gate 48"X72"

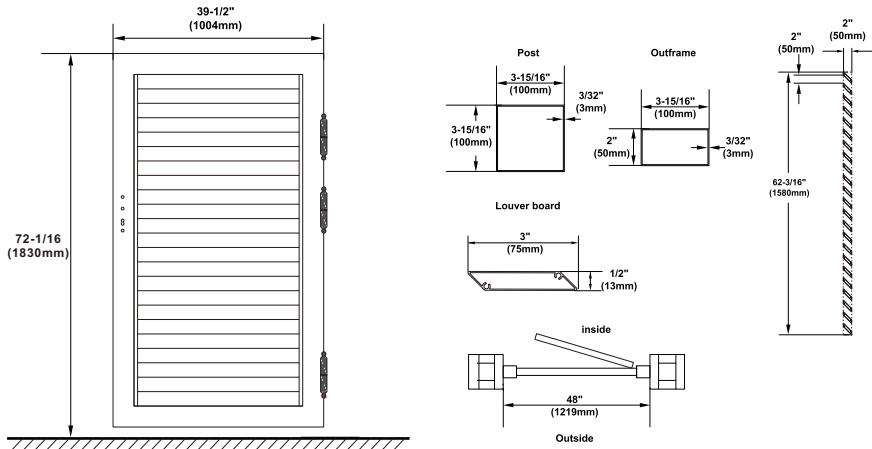

* The door only opens inwards.*

Specifications:

Height: 72-1/16" (1830mm)

Pack Quantity: 1 Panel per pack

Include: 6 Screws (M6*60mm)

Width: 39-1/2" (1004mm)

Material: Aluminum alloy

Thickness: 3-1/4" (82.5mm)

Finish: Matte Black

Product Overview:

- Aluminum Louver Swing Gate is a DIY-friendly solution with a modern design.
- The product is suitable for all kinds of extreme weather, can withstand high winds and is not easily blown over.
- The product offers the perfect combination of privacy and security while still allowing airflow.
- The product should be mounted on concrete ground.

UNIKOO LIMITED WARRANTY:

- UNIKOO warrants its commercial hardware for a period of 3 year from the date of purchase. UNIKOO commercial hardware is warranted against material and workmanship defects.
- All warranty claims are subject to inspection by UNIKOO before providing a resolution against the warranty claim.
- This warranty is void if it is determined after UNIKOO inspection that the Hardware has been improperly installed and/or maintained in a manner not conforming to UNIKOO guidelines and instructions provided at time of purchase.
- UNIKOO's responsibility to provide a resolution under said warranty will be limited to a refund of purchased price or provide a replacement for the hardware.
- The refund or replacement will constitute UNIKOO's limited liability and obligation for any and all defective material/workmanship for said warranty claim.
- THIS WARRANTY IS EXCLUSIVE AND UNIKOO MAKES NO OTHER WARRANTY, EXPRESSED OR IMPLIED.

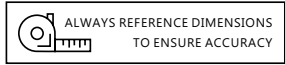

*Not shown to scale.

PFG72-01

Fence Gate Post 4"X72"

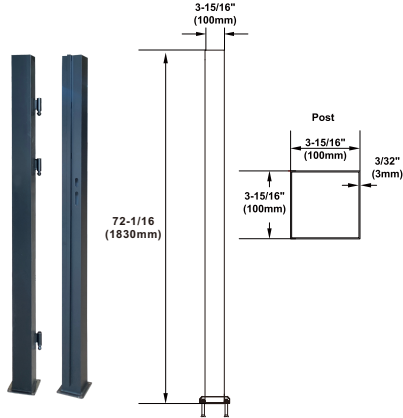

* Components sold separately*

LFG01

Fence Gate Lock

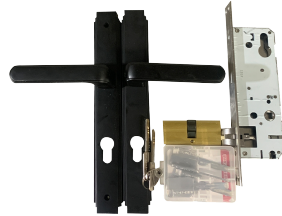

(Accessories Info: 2pcs of handle, 7pcs of key, 1pcs lock core, 1pcs lock body)

Specifications:

Height: 72-1/16" (1830mm)

Pack Quantity: 2 PCS/PK

Include: 2 pcs cover, 8 pcs pull screw

Width: 3-15/16" (100mm)

Material: Aluminum alloy

Thickness: 3-15/16" (100mm)

Finish: Matte Black

Product Overview:

- Fence Gate Post is a DIY-friendly solution with a modern design.
- The product is suitable for all kinds of extreme weather, can withstand high winds and is not easily blown over.
- The product offers the perfect combination of privacy and security while still allowing airflow.
- The product should be mounted on concrete ground.

UNIKOO LIMITED WARRANTY:

- UNIKOO warrants its commercial hardware for a period of 3 year from the date of purchase. UNIKOO commercial hardware is warranted against material and workmanship defects.
- All warranty claims are subject to inspection by UNIKOO before providing a resolution against the warranty claim.
- This warranty is void if it is determined after UNIKOO inspection that the Hardware has been improperly installed and/or maintained in a manner not conforming to UNIKOO guidelines and instructions provided at time of purchase.
- UNIKOO's responsibility to provide a resolution under said warranty will be limited to a refund of purchased price or provide a replacement for the hardware.
- The refund or replacement will constitute UNIKOO's limited liability and obligation for any and all defective material/workmanship for said warranty claim.
- THIS WARRANTY IS EXCLUSIVE AND UNIKOO MAKES NO OTHER WARRANTY, EXPRESSED OR IMPLIED.

GATE INSTALLATION

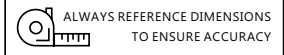

*Not shown to scale.

Aluminum Louver Swing Gate 48"X72"

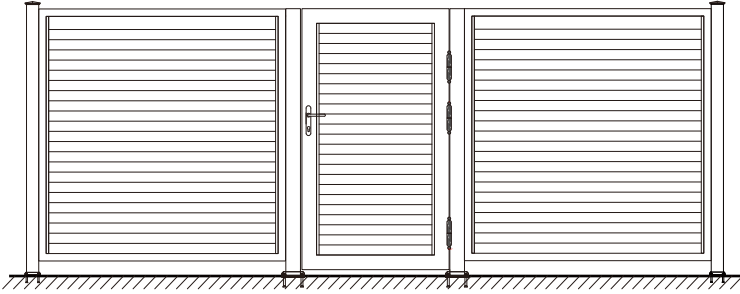

Note * Fence panel , post,gate panel are all sold separately *

* Above image for illustration purposes only *

1 Fix the pillar to the ground with screws

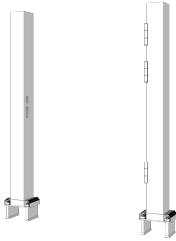

2 Hang the door on the hinge



3 Install locks

